

**RU**

ИНСТРУКЦИЯ ПО УСТАНОВКЕ  
Гидропневматические упоры

**GB**

INSTALLATION MANUAL  
GasLift

**SHERIFF**



**HYUNDAI Creta**

**2016 - **

10. UP 3201

03/07/17

1/5



**(RU)** Позиция/Расположение  
**(GB)** Location/Position Arrow

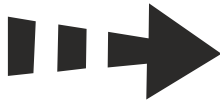

**(RU)** Движение  
**(GB)** Movement Arrow



**(RU)** Поворот  
**(GB)** Screw Arrow

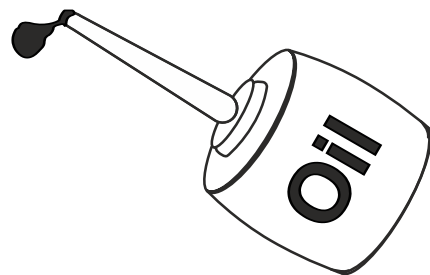
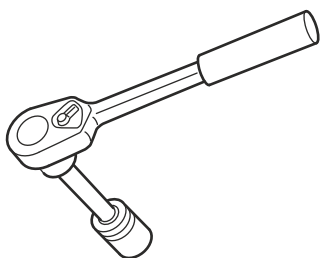
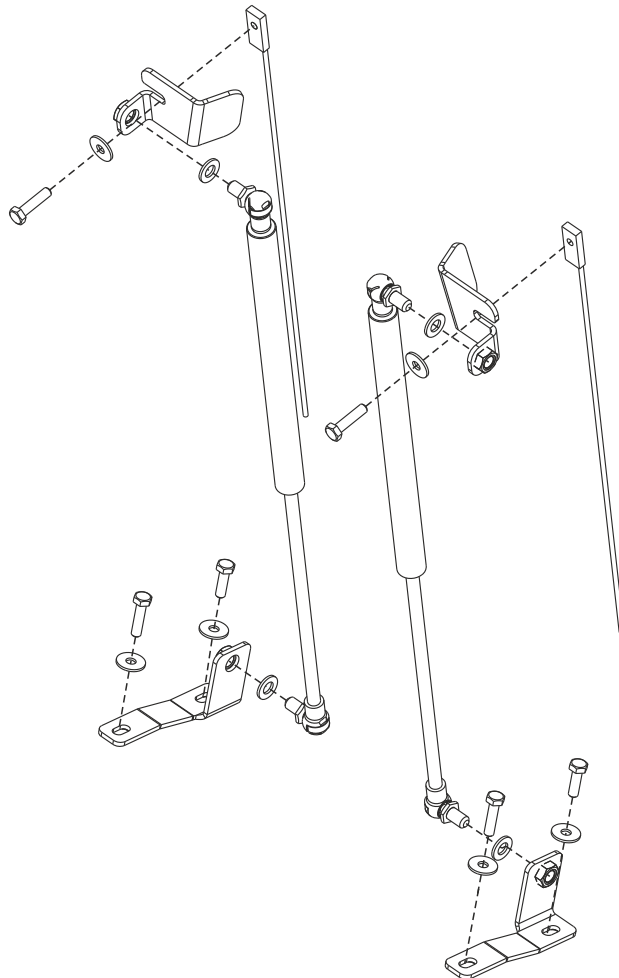

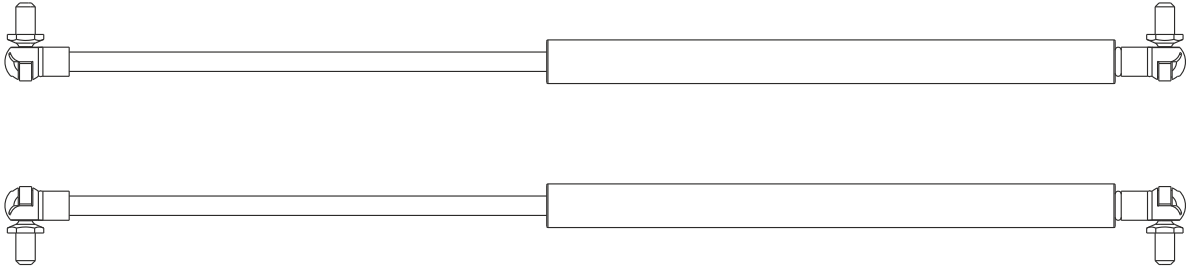
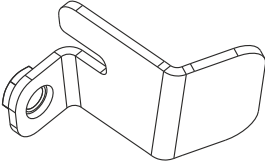
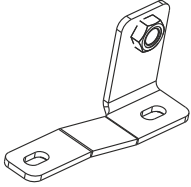
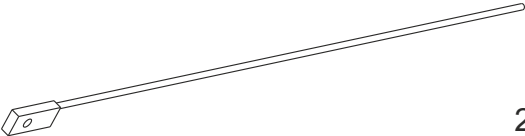
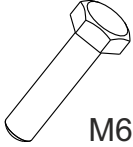
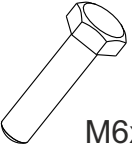
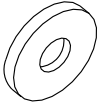
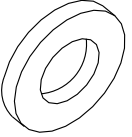
<b>A</b>			2X				
<b>B</b>		2X	<b>C</b> 	2X			
<b>D</b>			2X	<b>E</b> 	M6x20	2X	
<b>F</b>			M6x25	4X	<b>G</b> 	∅ 6	6X
<b>H</b>			∅ 8	4X			



**(GB)** ATTENTION! GasLift, you must set the rod down. Otherwise deteriorate damping characteristics and reduces the life of the product. May not get grease on the rod of the gasLift.

**(RU)** ВНИМАНИЕ! Газовый упор необходимо устанавливать штоком вниз. В противном случае ухудшаются амортизационные характеристики и снижается срок службы изделия. Не допускается попадание смазки на шток газового упора.

RS=LS

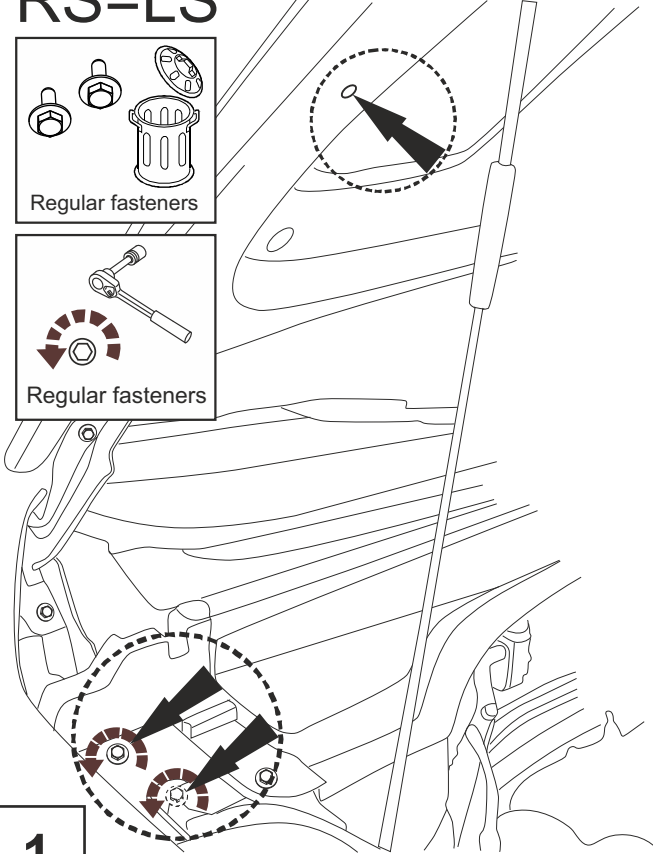
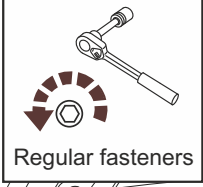
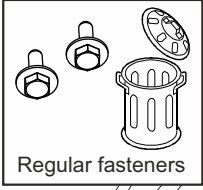

1

RS=LS

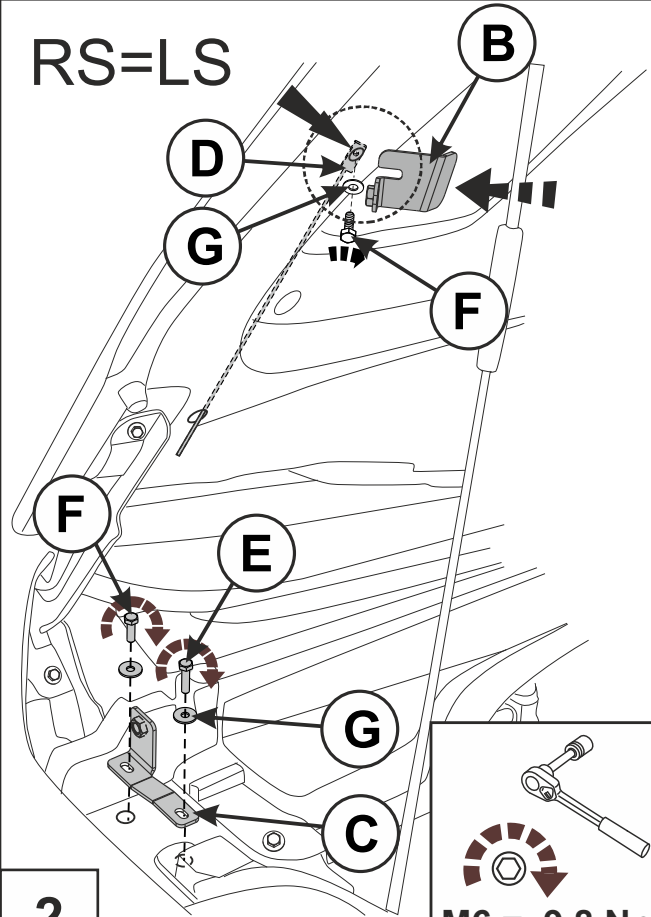

2

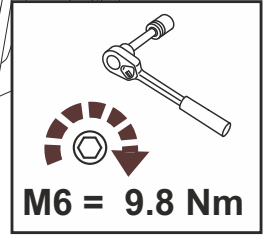

RS=LS

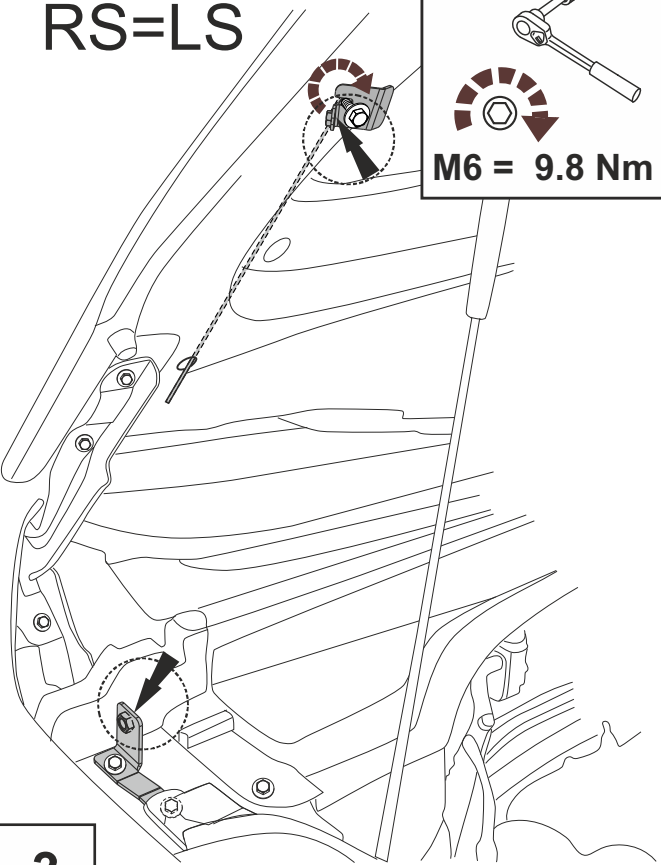
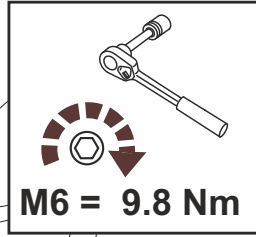

3

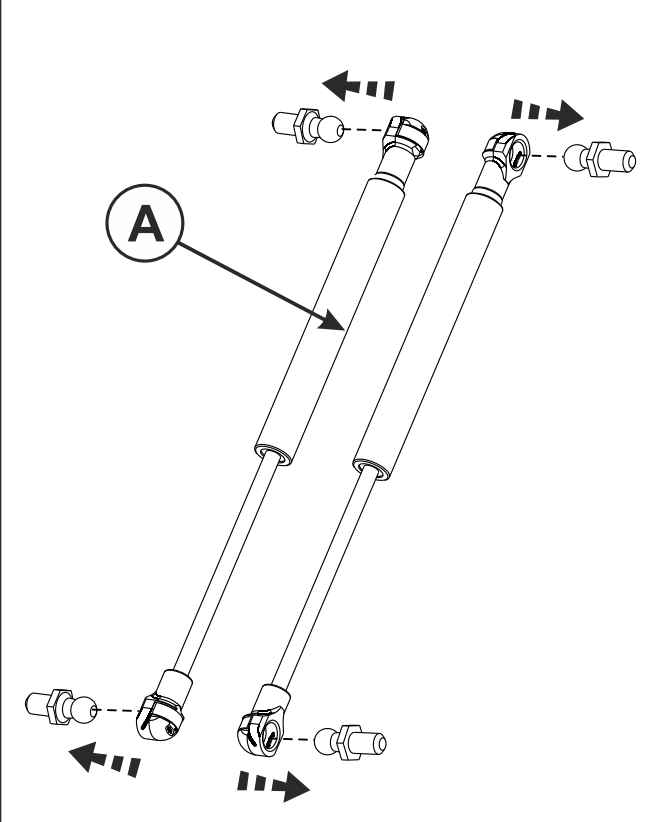

4

RS=LS

RS=LS

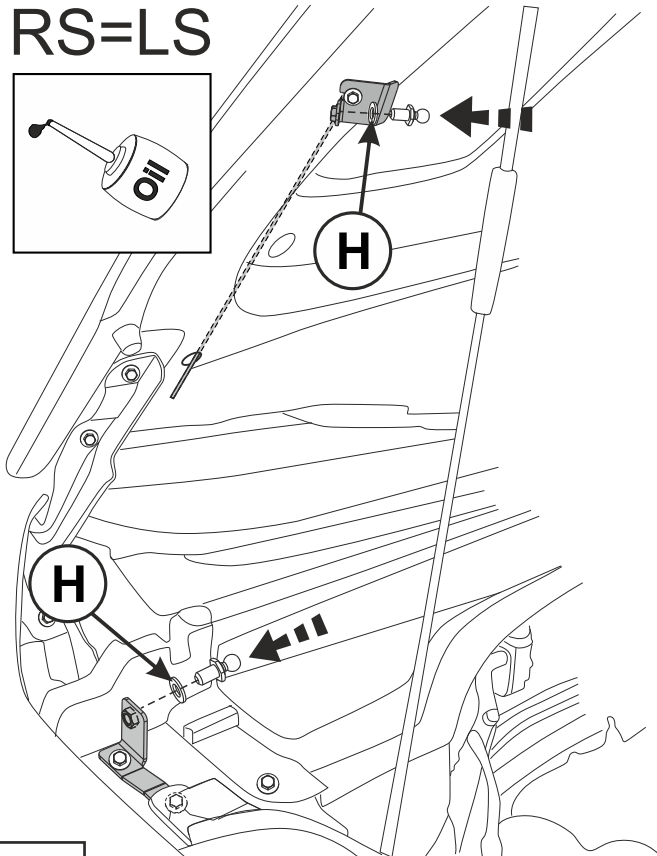
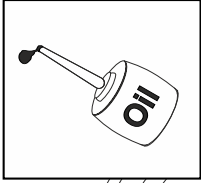

5

RS=LS

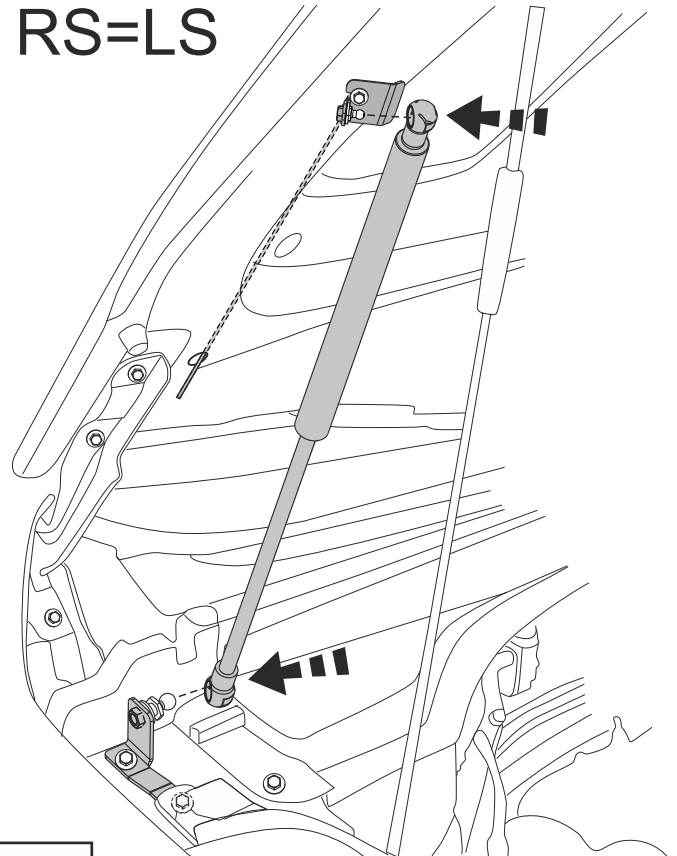

6

RS=LS

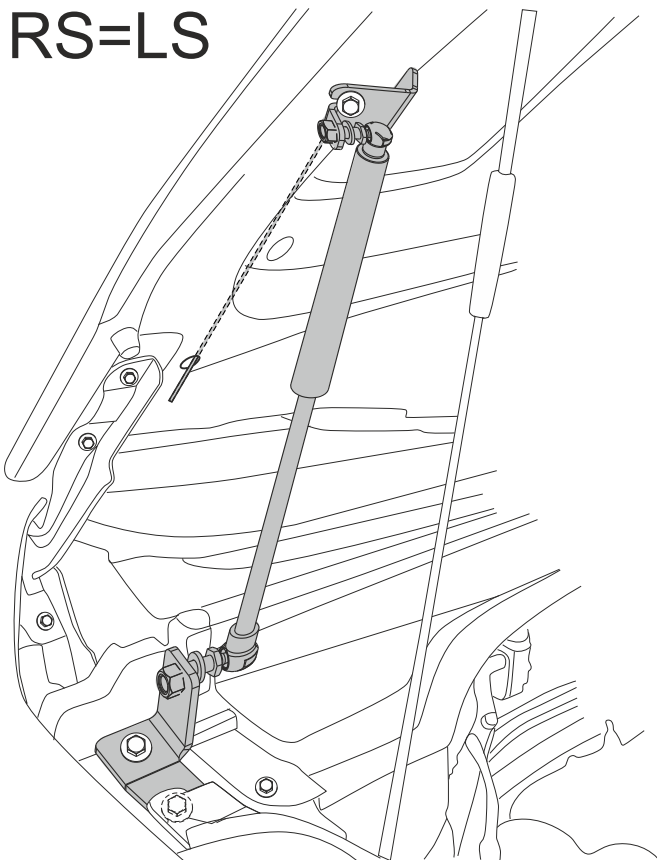

7

**GB** Holding the hood, remove a regular stop in the transport position and install the gazLift.

**RU** Удерживая капот, уберите штатный упор в транспортное положение и установите газовые упоры.

**GB** Gently close the hood. If the hood is not closed, check the installation.

**RU** Аккуратно закройте капот. В случае, если капот не закрылся, проверьте правильность установки.

**ГАРАНТИЯ:**

Гарантийный срок эксплуатации - 12 месяцев.