

Инструкция по установке **LADA XRAY** (2015-)

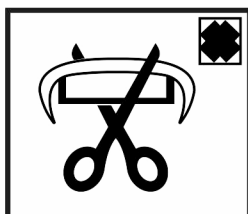

Арт.: F.6015.002

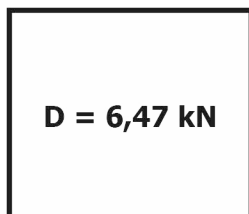
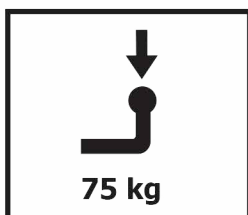
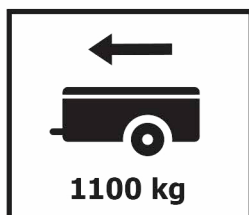

$$D \text{ (kN)} = \frac{\text{MAX kg} \times \text{MAX kg}}{\text{MAX kg} + \text{MAX kg}} \times 0,00981$$

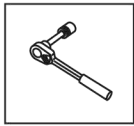

Вкрутить/выкрутить используя инструмент

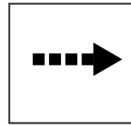

Движение

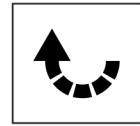

Поворот



Вкрутить/выкрутить не затягивая

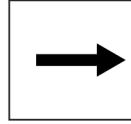

Расположение

Используемый инструмент:

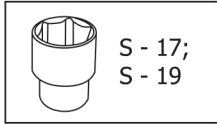
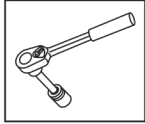





S - 17;
S - 19

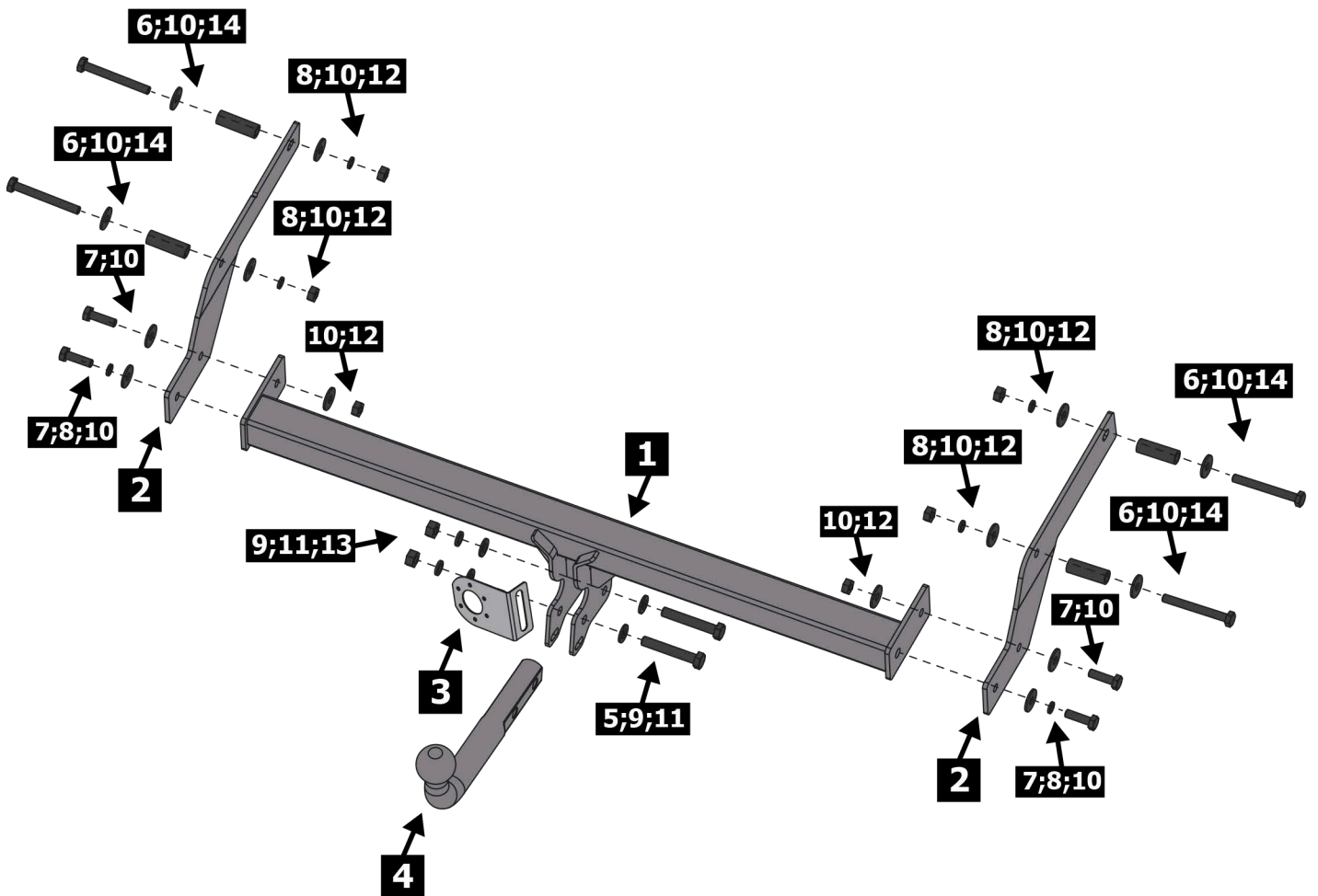

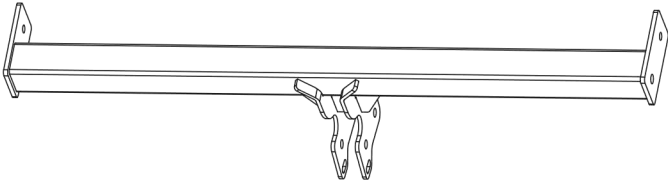
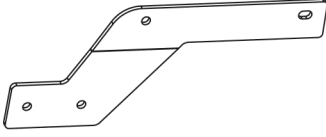
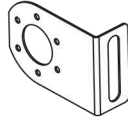
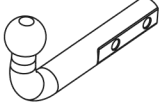
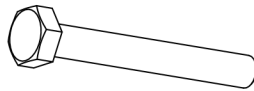
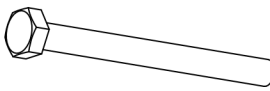
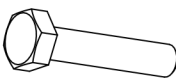
TORX 30;
TORX 20

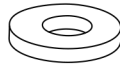

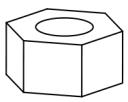
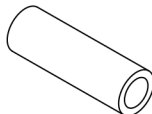
1	x1	Балка	
2	x2	Кронштейн	
3	x1	Подрозетник	
4	x1	Крюк	
5	x2	M12x75	
6	x4	M10x90	
7	x4	M10x35	
8	x6	∅ 10	
9	x2	∅ 12	
10	x14	∅ 10	
11	x4	∅ 12	
12	x6	M10	
13	x2	M12	
14	x4	Втулка	

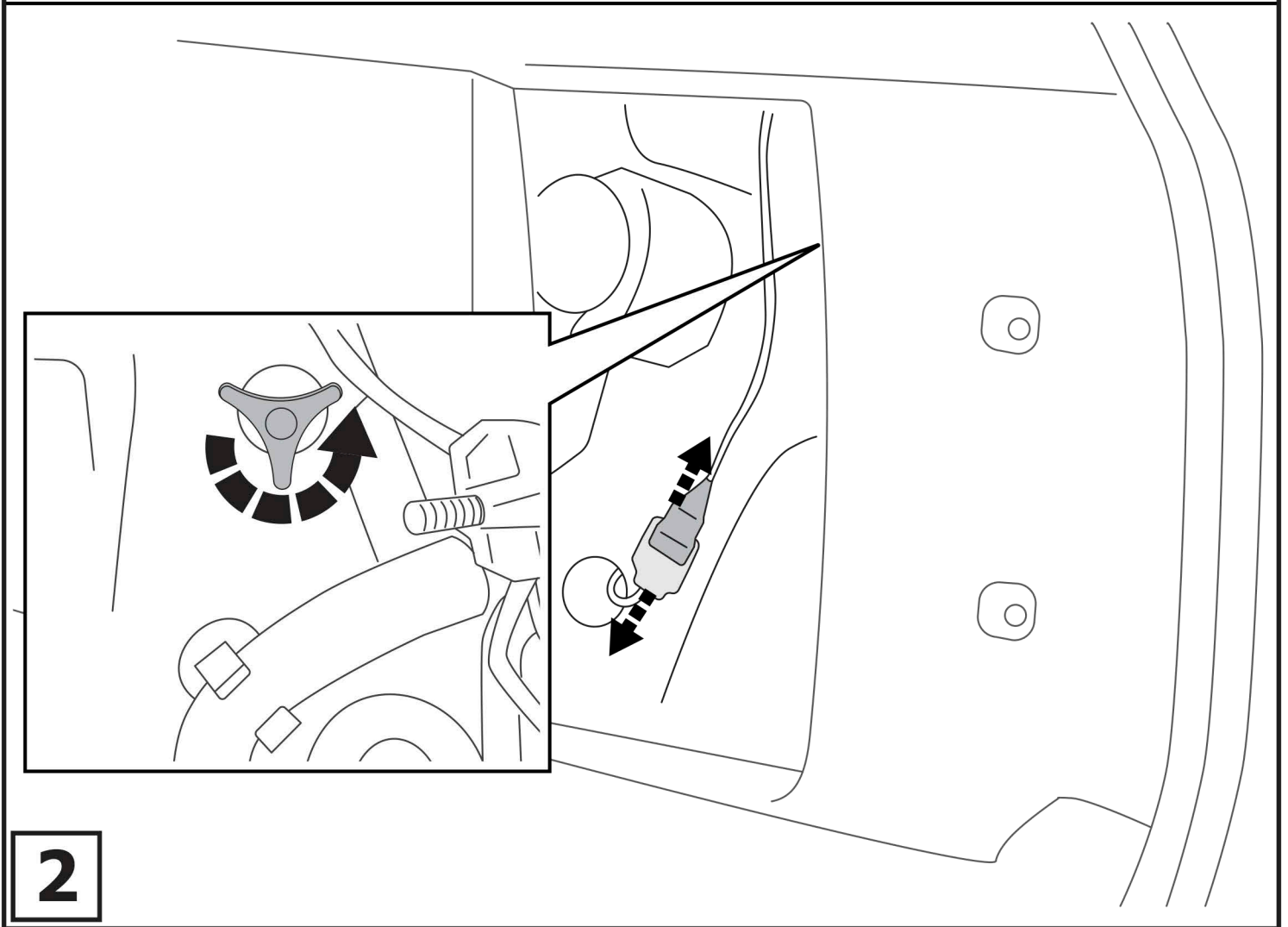
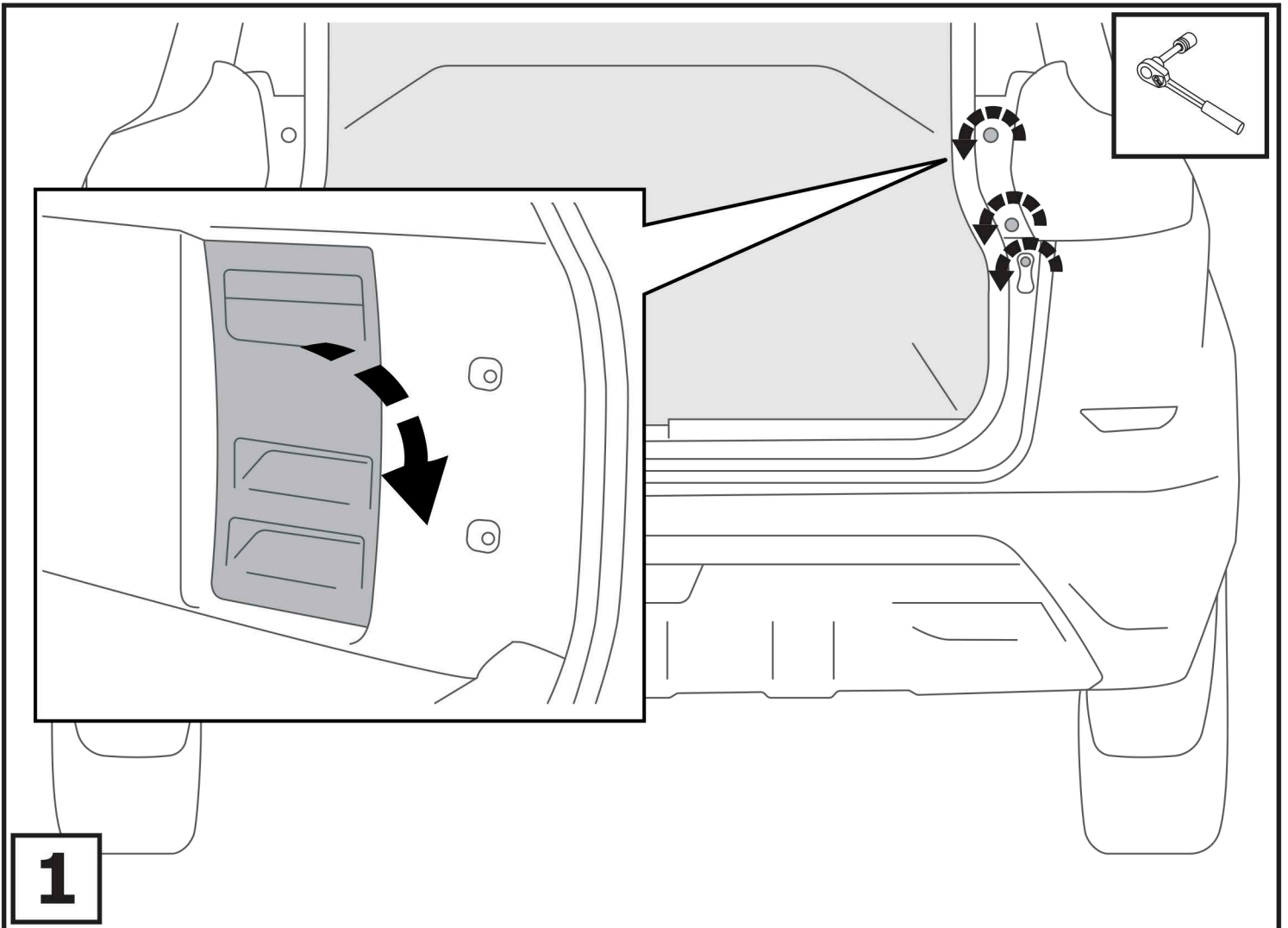

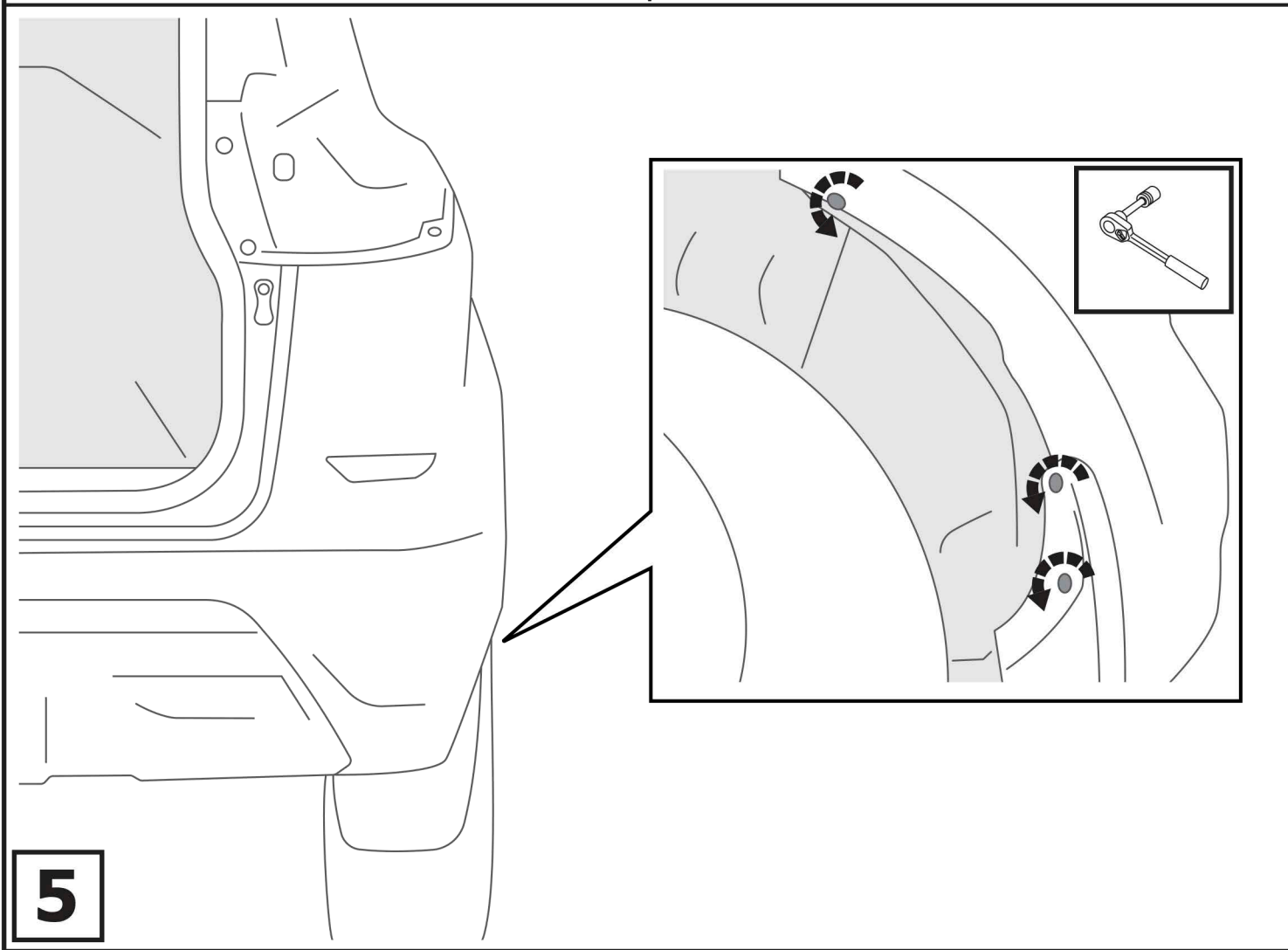
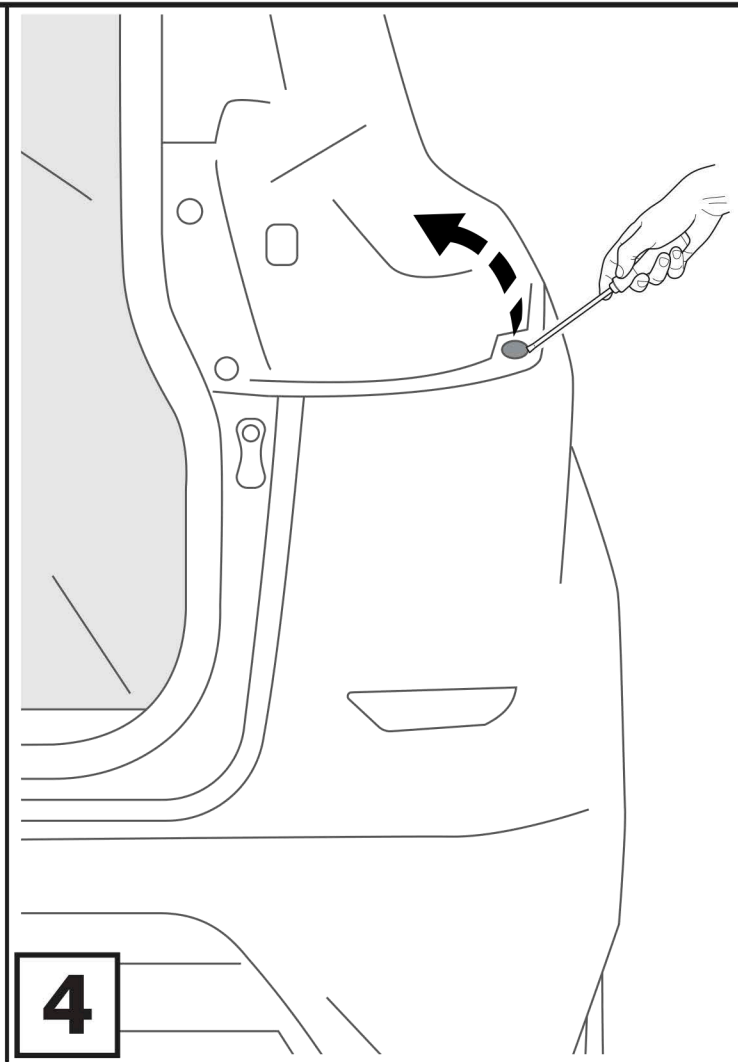
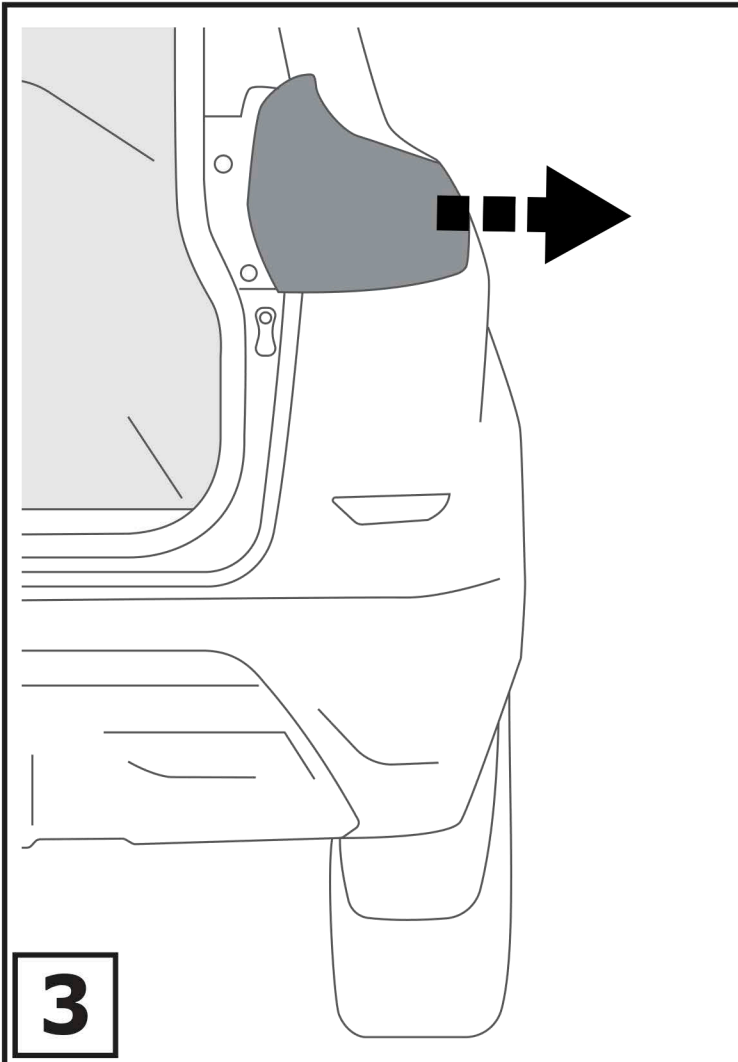

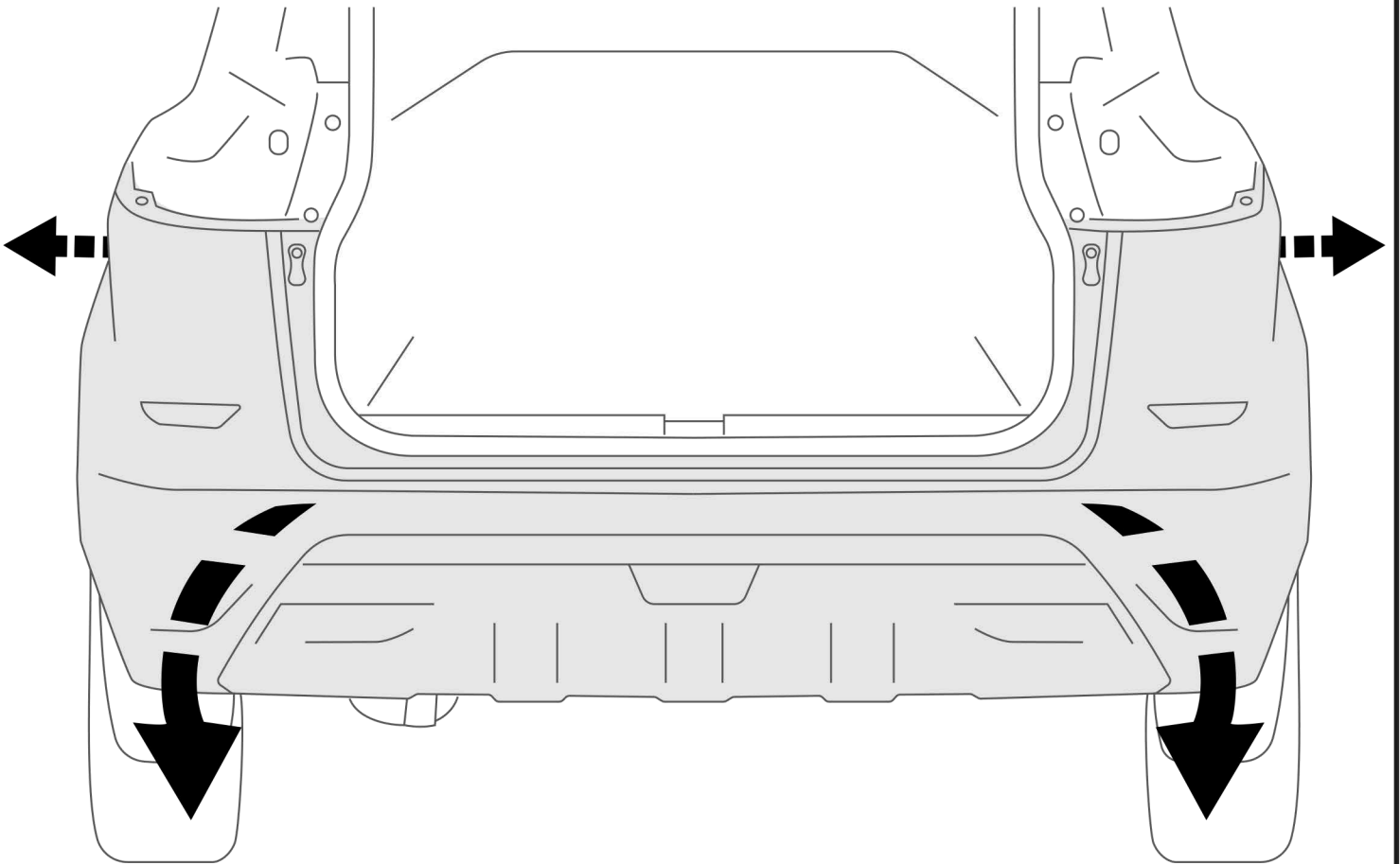
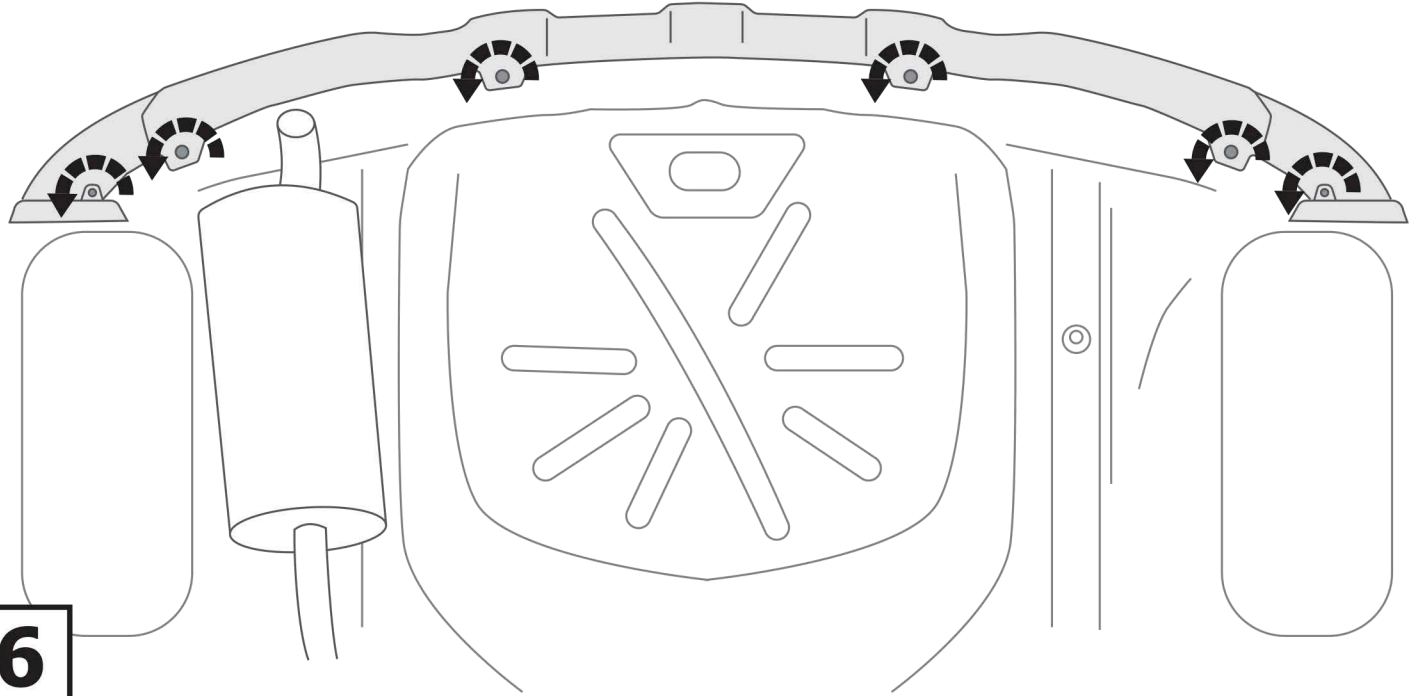
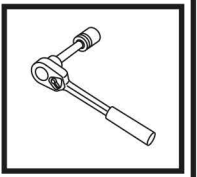
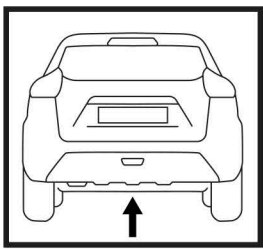

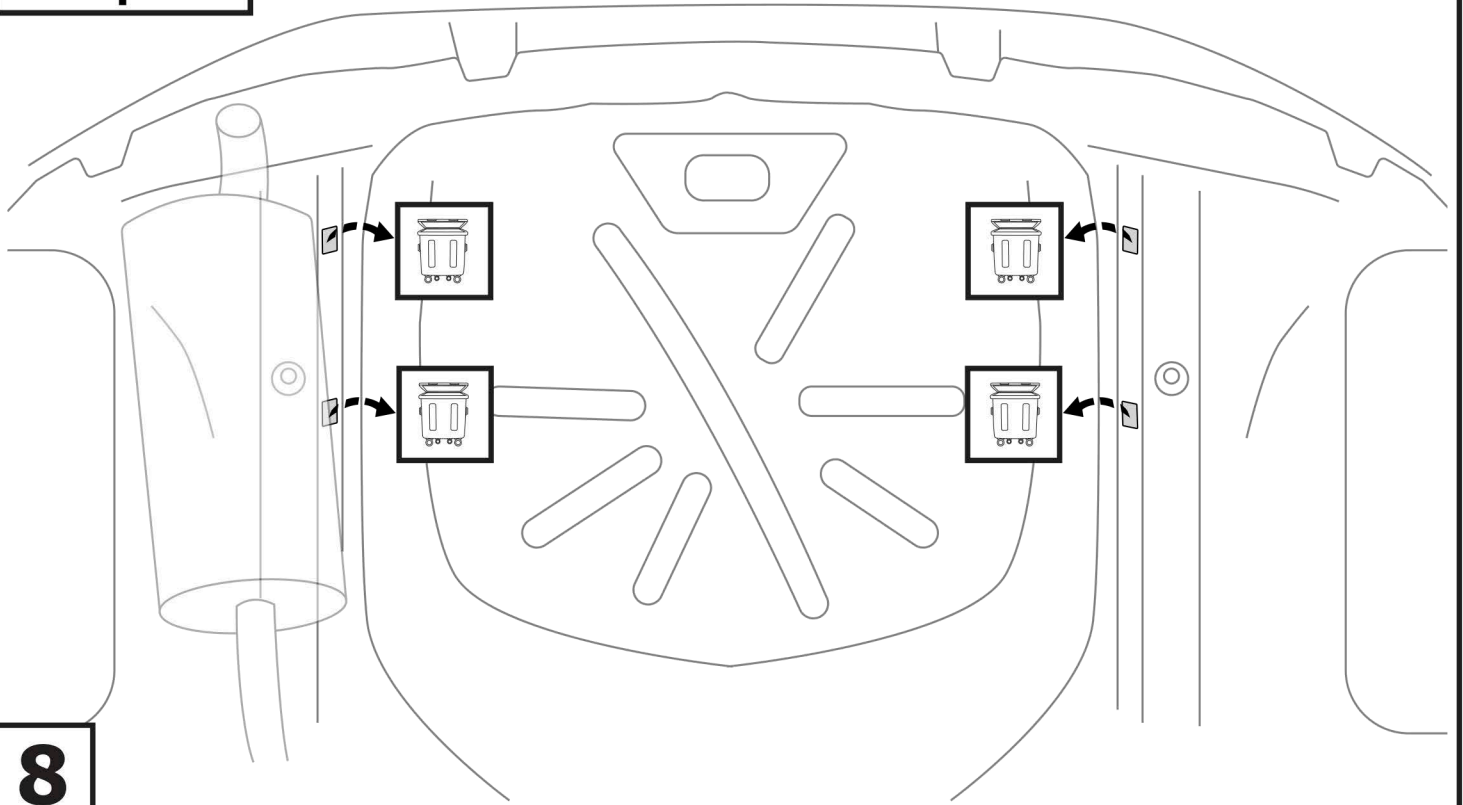
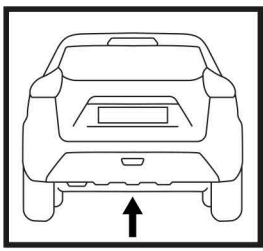

8

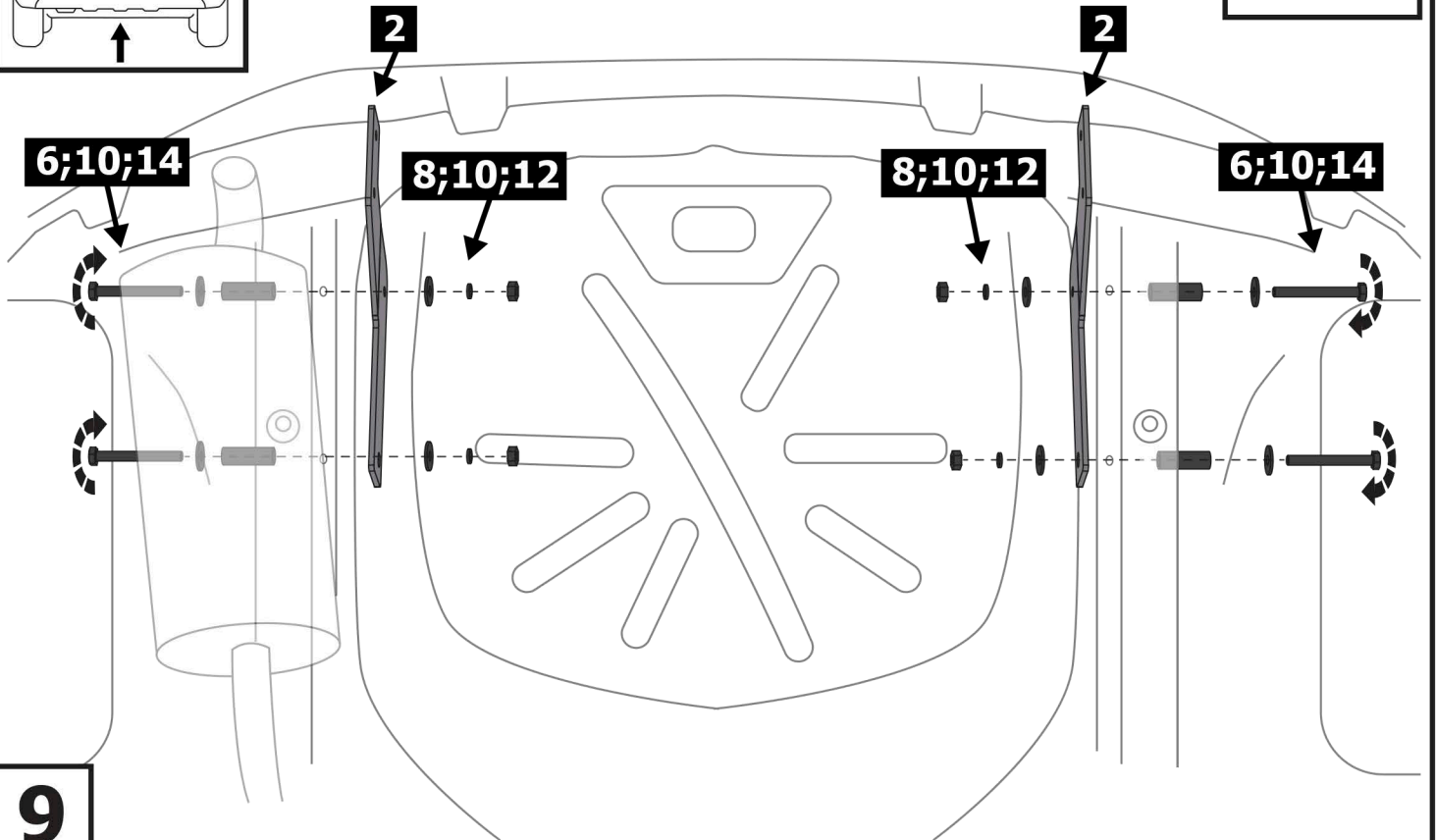
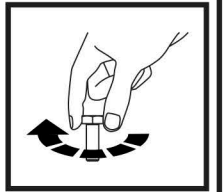
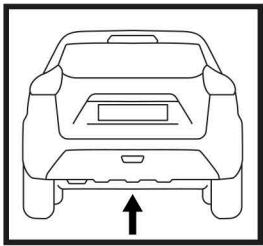

9

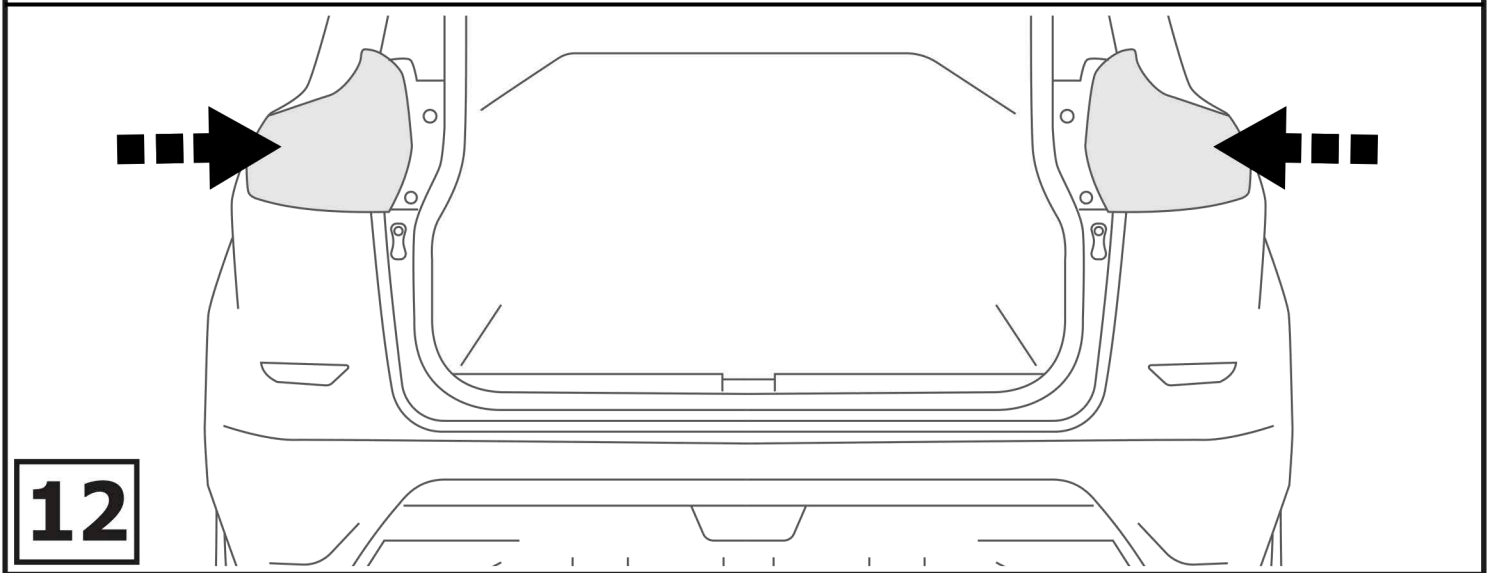
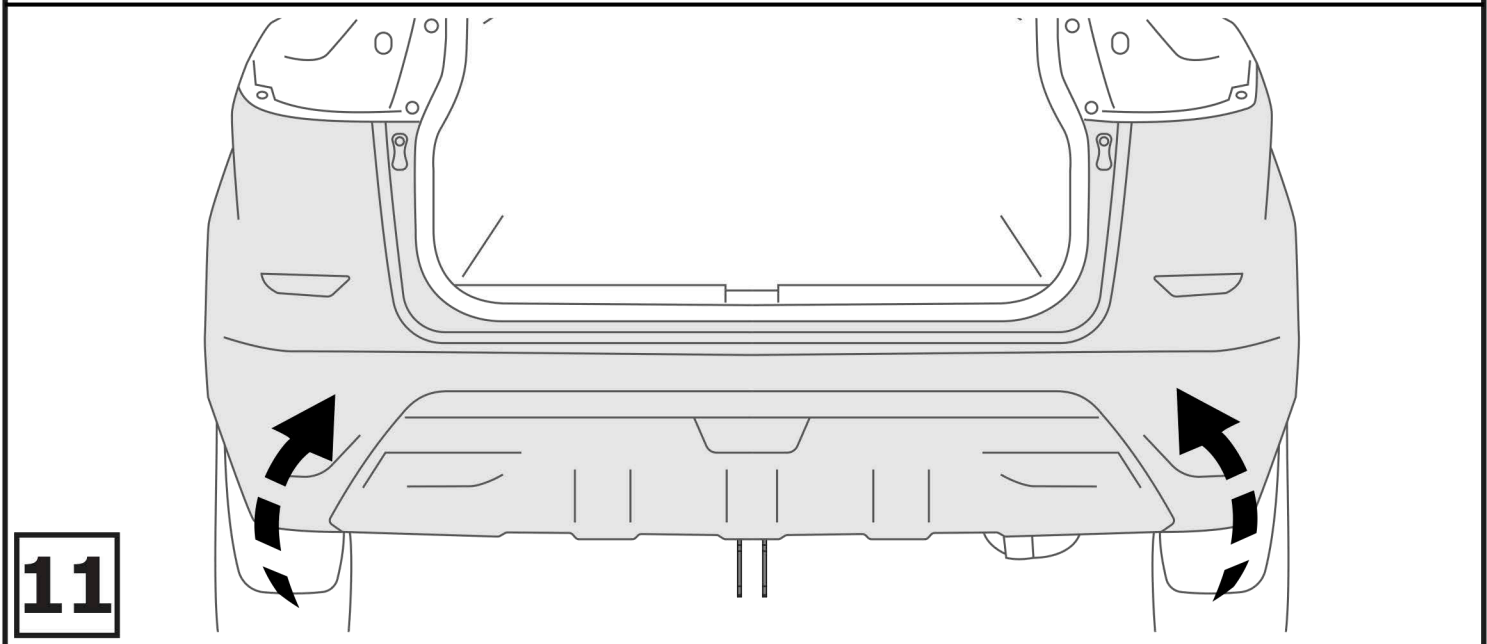
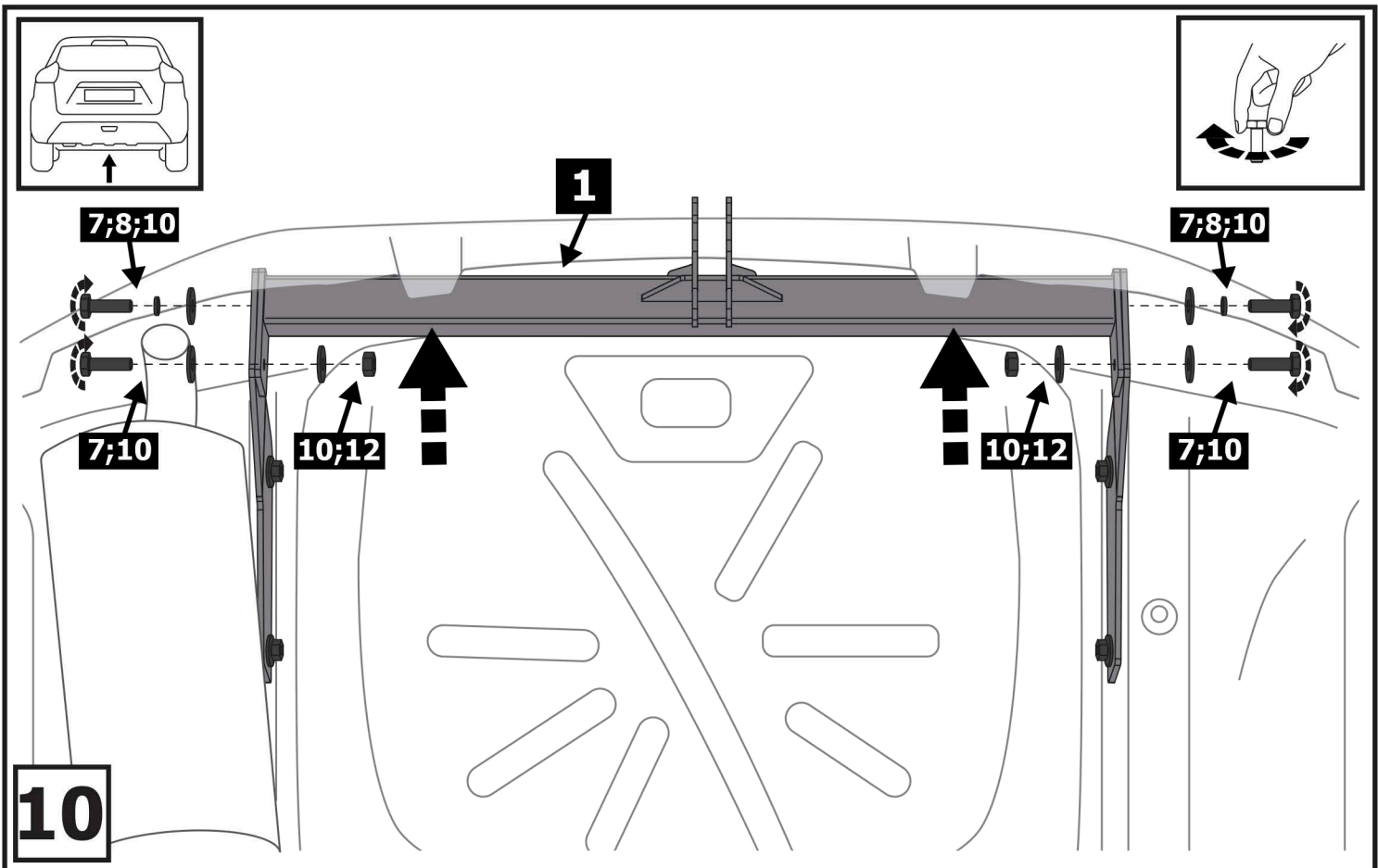

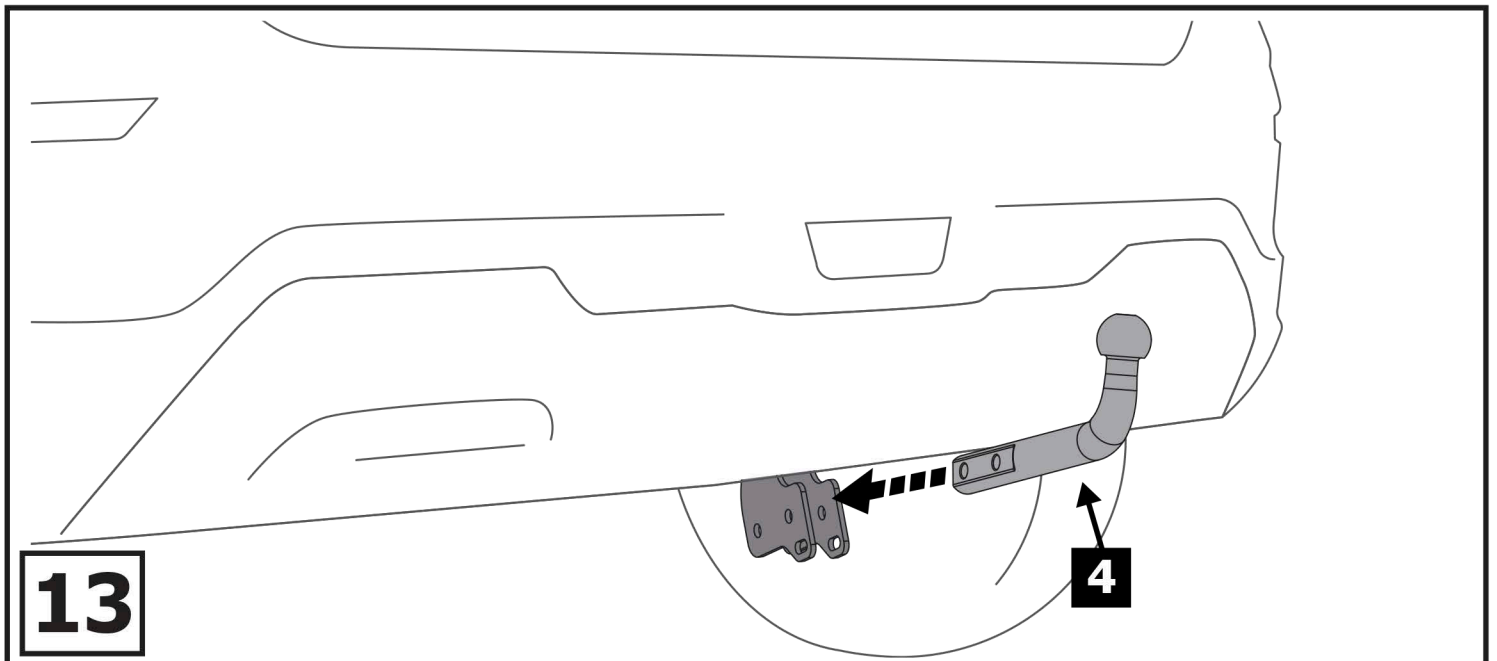

13

4

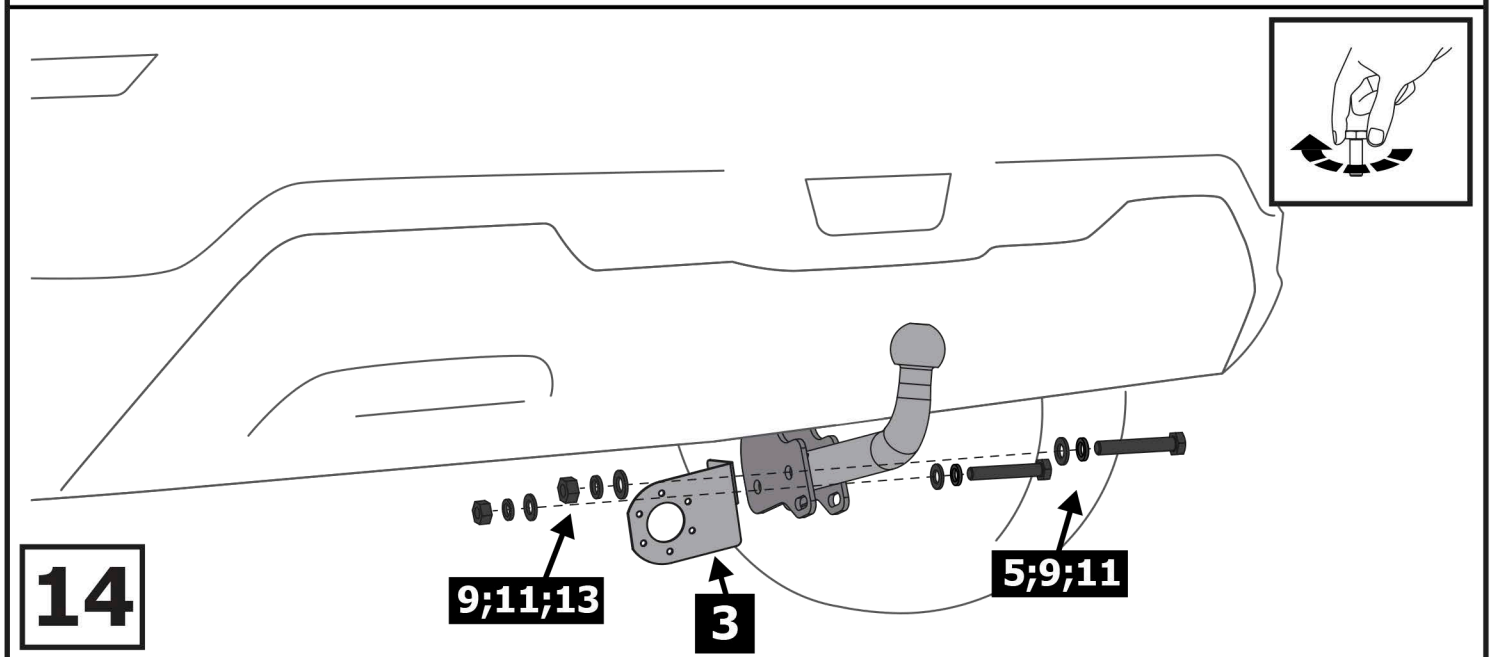

14

9;11;13

3

5;9;11



15

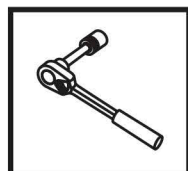

**Затянуть все резьбовые соединения
M10 = 47 Nm M12 = 81 Nm**